

1 Product Specification (产品技术规格)

No. (序号)	Item (项目)	General Parameter (常规参数)		Remark (备注)
1	Rated Capacity (额定容量)	Typical (标称容量)	140mAh	Standard discharge (0.2C C ₅ A) after Standard charge (标准充电后 0.2C ₅ A 标准放电)
		Minimum (最小容量)	140mAh	
2	Nominal Voltage (正常电压)	3.7V		Mean Operation Voltage (即工作电压)
3	Voltage at end of Discharge (放电终止电压)	2.75V		Discharge Cut-off Voltage (放电截止电压)
4	Charging Voltage (充电电压)	4.2 ± 0.03V		
5	Internal Impedance (内阻)	≤ 150m Ω		Internal resistance measured at AC 1KHz after 50% charge (半电态下用交流法测量内阻) The measure must uses the new batteries that within one week after shipment and cycles less than 5 times (使用出货后不到一个星期及循环次 数少于 5 次的新电池测量)
6	Standard charge (标准充电)	Constant Current 0.5C ₅ A Constant Voltage 4.2V 0.01 C ₅ A cut-off (持续电流: 0.5C ₅ A 持续电压: 4.2V 截止电流: 0.01 C ₅ A)		Charge time : Approx 4.0h (充电时间: 大约 4 个小时)
7	Standard discharge (标准放电)	Constant current 0.2 C ₅ A end voltage 2.75V (持续电流: 0.2C ₅ A 截止电压: 2.75V)		
8	Fast charge (快速充电)	Constant Current 1C ₅ A Constant Voltage 4.2V 0.01 C ₅ A cut-off (持续电流: 1C ₅ A 持续电压: 4.2V 截止电流: 0.01 C ₅ A)		Charge time : Approx 2.5h (充电时间: 大约 2.5 个小时)

Continuous the table 1 (续表 1)

No. (序号)	Item (项目)	General Parameter (常规参数)	Remark (备注)
9	Fast discharge (快速放电)	Constant current 1 C ₅ A end voltage 2.75V (持续电流: 1 C ₅ A 截止电压: 2.75V)	
10	Maximum Continuous Charge Current (最大充电持续电流)	1 C ₅ A	
11	Maximum Continuous Discharge Current (最大放电持续电流)	1.5C ₅ A	
12	Operation Temperature Range (工作温度范围)	Charge (充电): 0~45°C	60±25%R.H. Bare Cell (单体电池储存湿度范围)
		Discharge (放电): -20~60°C	
13	Storage Temperature Range (储存温度范围)	Less than 1 year: -20~25°C (小于一年: -20~25°C)	60±25%R.H. at the shipment state (出货状态时的湿度范围)
		less than 3 months: -20~40°C (小于3个月: -20~40°C)	
14	Pack Dimension (包装后尺寸)	Height: Max 35.5mm (高度: 最大 35.5 mm)	Initial Dimension (初始尺寸)
		Width: Max 12.5 mm (宽度: 最大 12.5 mm)	
		Thickness: Max 5.05mm (厚度: 最大 5.05mm)	

PX 501235

Polymer Li-ion Battery

PX501235 3.7V 140MAH

POWER-XTRA

Initial Dimension: (初始尺寸)

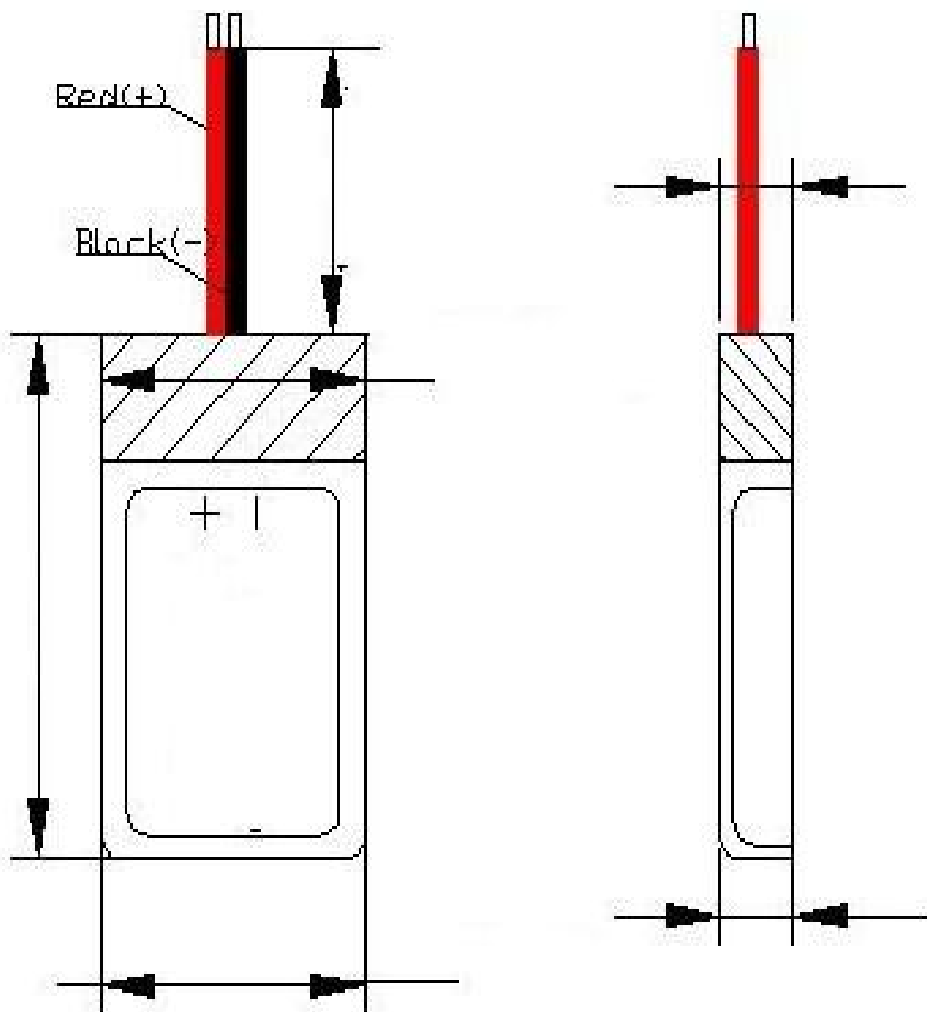

Units (单位)		mm	PCB (保护板)		A-3626	
Wire(引线)		1007/24#	L(线长)	10±2	L1 (剥线)	1.0-2.0
T (厚度)		5.2 ^{+0.2} _{-0.2}	W (宽度)	12.0 ^{+0.5} _{-0.5}	H (高度)	35.0 ^{+1.5} _{-1.5}
Drawer		Checked		Approved		Date
(绘图)		(审核)		(批准)		(期)
			PL501235 DRAWING			
			Drawing ID (图号)			